

PERFORMANCE  
MADE  
SMARTER

# Product manual **3225**

## *Universal frequency converter*

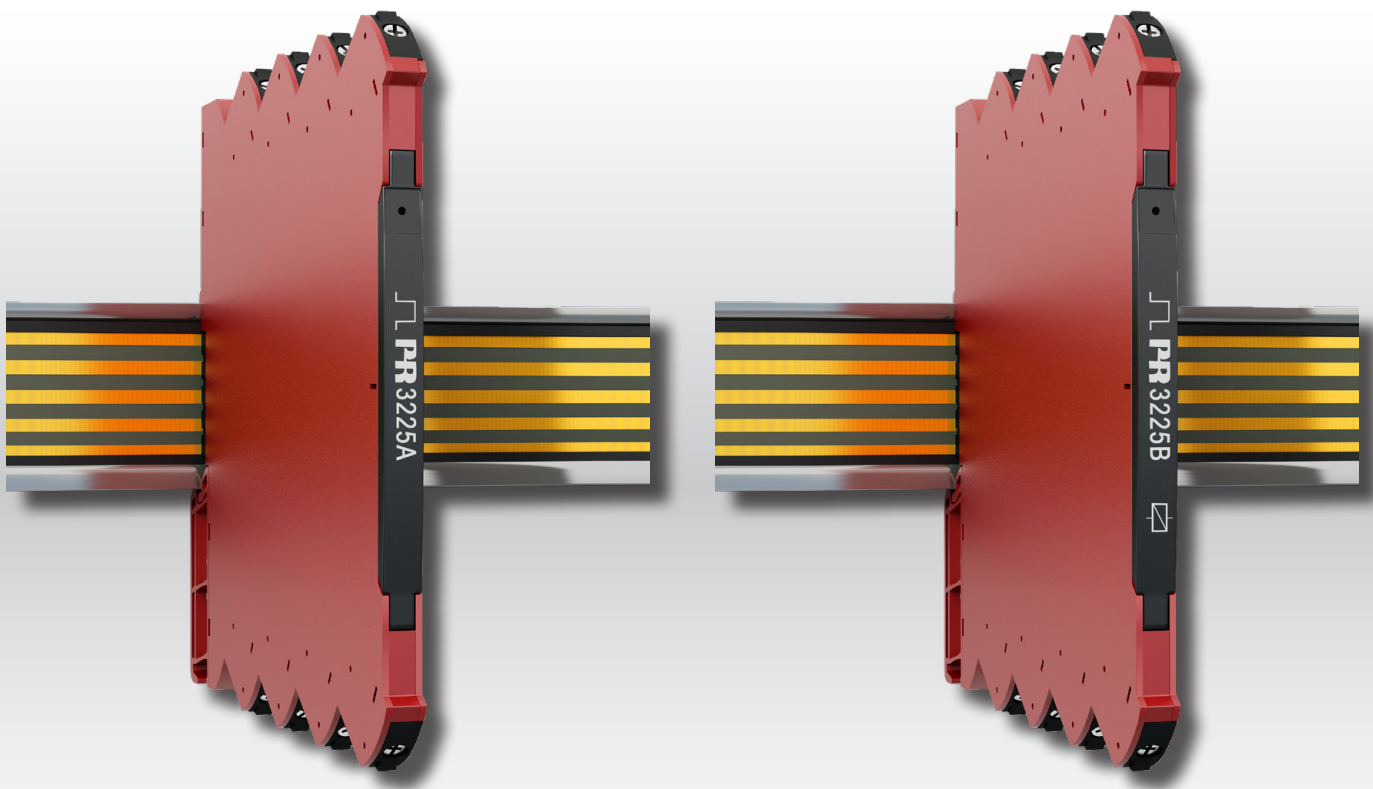

TEMPERATURE | I.S. INTERFACES | COMMUNICATION INTERFACES | MULTIFUNCTIONAL | ISOLATION | DISPLAY

No. 3225V100-UK  
Serial no.: 211449001-222139000

**PR**  
electronics

# 6 Product Pillars

## *to meet your every need*

### Individually outstanding, unrivalled in combination

With our innovative, patented technologies, we make signal conditioning smarter and simpler. Our portfolio is composed of six product areas, where we offer a wide range of analog and digital devices covering over a thousand applications in industrial and factory automation. All our products comply with or surpass the highest industry standards, ensuring reliability in even the harshest of environments and have a 5-year warranty for greater peace of mind.



Temperature

Our range of temperature transmitters and sensors provides the highest level of signal integrity from the measurement point to your control system. You can convert industrial process temperature signals to analog, bus or digital communications using a highly reliable point-to-point solution with a fast response time, automatic self-calibration, sensor error detection, low drift, and top EMC performance in any environment.



I.S. Interface

We deliver the safest signals by validating our products against the toughest safety standards. Through our commitment to innovation, we have made pioneering achievements in developing I.S. interfaces with SIL 2 Full Assessment that are both efficient and cost-effective. Our comprehensive range of analog and digital intrinsically safe isolation barriers offers multifunctional inputs and outputs, making PR an easy-to-implement site standard. Our backplanes further simplify large installations and provide seamless integration to standard DCS systems.



Communication

We provide inexpensive, easy-to-use, future-ready communication interfaces that can access your PR installed base of products. All the interfaces are detachable, have a built-in display for readout of process values and diagnostics, and can be configured via push-buttons. Product specific functionality includes communication via Modbus and Bluetooth and remote access using our PR Process Supervisor (PPS) application, available for iOS and Android.



Multifunction

Our unique range of single devices covering multiple applications is easily deployable as your site standard. Having one variant that applies to a broad range of applications can reduce your installation time and training, and greatly simplify spare parts management at your facilities. Our devices are designed for long-term signal accuracy, low power consumption, immunity to electrical noise and simple programming.



Isolation

Our compact, fast, high-quality 6 mm isolators are based on microprocessor technology to provide exceptional performance and EMC-immunity for dedicated applications at a very low total cost of ownership. They can be stacked both vertically and horizontally with no air gap separation between units required.



Display

Our display range is characterized by its flexibility and stability. The devices meet nearly every demand for display readout of process signals and have universal input and power supply capabilities. They provide a real-time measurement of your process value no matter the industry and are engineered to provide a user-friendly and reliable relay of information, even in demanding environments.

# Universal frequency converter 3225

## Table of contents

Warnings .....	4
Symbol identification .....	4
Safety instructions .....	5
Mounting / demounting of system 3000 .....	6
Installation on DIN rail / power rail .....	7
Marking .....	7
Flexible supply .....	8
Functional highlights .....	9
Connections .....	10
Block diagram .....	11
Specifications .....	12
Order .....	12
Accessories for power rail devices .....	12
Technical characteristics .....	12
Programming .....	17
DIP-switch configuration .....	17
PR 4590 ConfigMate programming .....	19
Configurable input error indication and input limits .....	20
Low cut-off function .....	22
Square root function .....	22
Relay functions 3225B .....	24
Graphic depiction of relay action setpoint .....	25
Graphic depiction of relay action window .....	25
Advanced settings menu .....	27
Routing diagram - 3225A .....	28
Routing diagram - 3225B .....	29
Help text overview .....	30
Operation & troubleshooting .....	32
Installation instructions .....	33
UL installation .....	33
IECEX, ATEX and UKCA installation in Zone 2 .....	33
Document history .....	34

## Warnings



**GENERAL**

This device is designed for connection to hazardous electric voltages. Ignoring this warning can result in severe personal injury or mechanical damage.

To avoid the risk of electric shock and fire, the safety instructions of this product manual must be observed, and the guidelines followed. The specifications must not be exceeded, and the device must only be applied as described in the following.

Prior to the commissioning of the device, this product manual must be examined carefully.

Only qualified personnel (technicians) should install this device. If the equipment is used in a manner not specified by the manufacturer, the protection provided by the equipment may be impaired.



**HAZARDOUS  
VOLTAGE**

Until the device is fixed, do not connect hazardous voltages to the device.

In applications where hazardous voltage is connected to in-/outputs of the device, sufficient spacing or isolation from wires, terminals, and enclosure - to surroundings (incl. neighboring devices), must be ensured to maintain protection against electric shock.

The following operations should only be carried out on a disconnected device and under ESD-safe conditions:

General mounting, connection, and disconnection of wires.

Troubleshooting the device.



**CAUTION**

**Repair of the device and replacement of circuit breakers must be done by PR electronics A/S only.**

Potential electrostatic charging hazard. To avoid the risk of explosion due to electrostatic charging of the enclosure, do not handle the units unless the area is known to be safe, or appropriate safety measures are taken to avoid electrostatic discharge.

## Symbol identification



**Triangle with an exclamation mark:** Warning /demand. Potentially lethal situations. Read the manual before installation and commissioning of the device in order to avoid incidents that could lead to personal injury or mechanical damage.



**The CE mark** proves the compliance of the device with the essential requirements of the directives.



**The UKCA mark** proves the compliance of the device with the essential requirements of the UK regulations.



**The double insulation symbol** shows that the device is protected by double or reinforced insulation.



Ex devices have been approved acc. to the ATEX directive for use in connection with installations in explosive areas. See installation instructions.

# Safety instructions

## Definitions

**Hazardous voltages** have been defined as the ranges: 75 to 1500 Volt DC, and 50 to 1000 Volt AC.

**Technicians** are qualified persons educated or trained to mount, operate, and also trouble-shoot technically correct and in accordance with safety regulations.

**Operators** are personnel familiar with the contents of this manual and capable of safe operation of the device.

## Receipt and unpacking

Unpack the device without damaging it and check whether the device type corresponds to the one ordered. The packing should always follow the device until this has been permanently mounted.

## Environment

Avoid direct sun light, dust, high temperatures, mechanical vibrations and shock, and rain and heavy moisture. If necessary, heating in excess of the stated limits for ambient temperatures should be avoided by way of ventilation.

The device must be installed in pollution degree 2 or better.

The device is designed to be safe at least under an altitude up to 2000 m.

The device is designed for indoor use.

## Mounting

Only technicians who are familiar with the technical terms, warnings, and instructions in the manual and who are able to follow these should connect the device. Should there be any doubt as to the correct handling of the device, please contact your local distributor or, alternatively,

**PR electronics A/S**  
**[www.prelectronics.com](http://www.prelectronics.com)**

Mounting and connection of the device should comply with national legislation for mounting of electric materials, e.g. wire cross section, protective fuse, and location.

Descriptions of input / output and supply connections are shown in the block diagram and side label.

The device is provided with field wiring terminals and shall be supplied from a Power Supply having double / reinforced insulation. A power switch should be easily accessible and close to the device. The power switch shall be marked as the disconnecting unit for the device.

SYSTEM 3000 must be mounted on a DIN rail according to EN 60715.

Year of manufacture can be taken from the first two digits in the serial number.

## Calibration and adjustment

During calibration and adjustment, the measuring and connection of external voltages must be carried out according to the specifications of this manual. The technician must use tools and instruments that are safe to use.

## Normal operation

Operators are only allowed to adjust and operate devices that are safely fixed in panels, etc., thus avoiding the danger of personal injury and damage. This means there is no electrical shock hazard, and the device is easily accessible.

## Cleaning

When disconnected, the device may be cleaned with a cloth moistened with distilled water.

## Liability

To the extent the instructions in this manual are not strictly observed, the customer cannot advance a demand against PR electronics A/S that would otherwise exist according to the concluded sales agreement.

## Mounting / demounting of system 3000

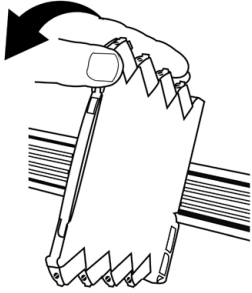
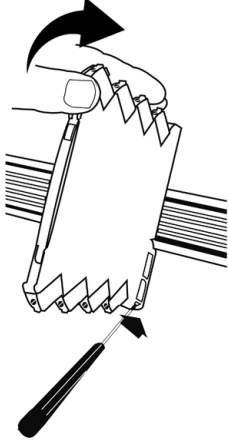
Mounting on DIN rail / power rail (Fig.1)	Demounting from DIN rail / power rail (Fig.2)
Click the device onto the rail	First, remember to demount the connectors with hazardous voltages. Detach the device from the rail by moving the bottom lock down.
	



System 3000 devices can be mounted on DIN rail or power rail (where applicable).  
When installing system 3000 devices with power rail connectors on a standard 7.5 mm DIN rail the head of the screws holding the rail shall be no more than 3.5 mm high to prevent potential short circuit of the power rail connectors.

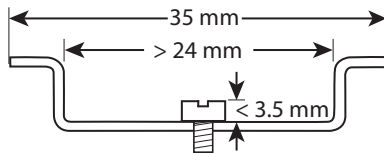

## Installation on DIN rail / power rail

The 3225 can be installed on a DIN rail or on a power rail.

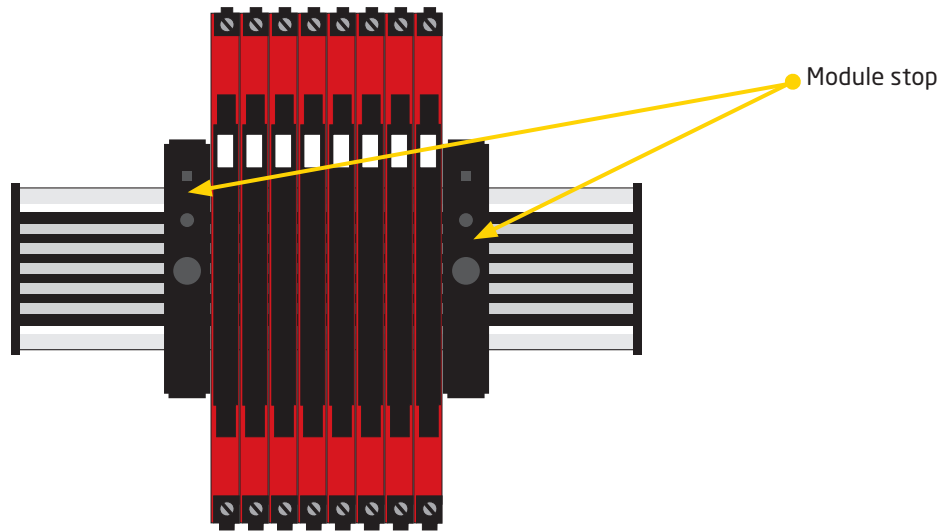

For marine applications, the devices must be supported by a module stop (PR part number 9404).

Power supply units can be mounted on the power rail according to customer requirements.

## Marking

The front cover of the 3225 has been designed with an area for affixation of a click-on marker. The area assigned to the marker measures 5 x 7.5 mm. Markers from Weidmüller's MultiCard System, type MF 5/7.5, are suitable.

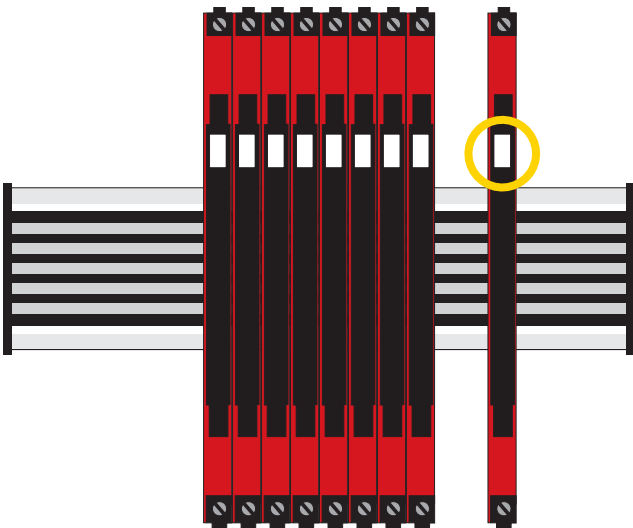

# Flexible supply

The technical specifications specify the maximum required power at nominal operating values, e.g. 24 V supply voltage, 60°C ambient temperature, 600 Ω load, and 20 mA output current.

External protective fuses may be required depending on power source selected. Protective fuse ratings are specified below.

## DIN rail solution - device daisy chain:

The units can be supplied with 24 VDC  $\pm$ 30% via direct wiring and a loop between the devices.

Protective fuse: 2.5 A.

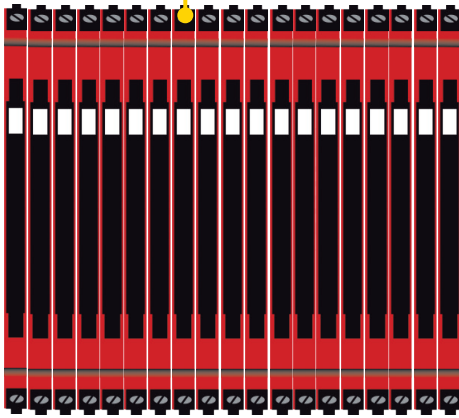

Protective fuse: 0.4 A.

## Power rail solution #1:

Alternately, you can connect 24 VDC to any 3000 device with power rail connector which will then energize other units on the rail.

## Power rail solution #2:

The PR 3405 power connector unit allows easy connection of a 24 VDC / 2.5 A source to the power rail.

Protective fuse: 2.5 A.

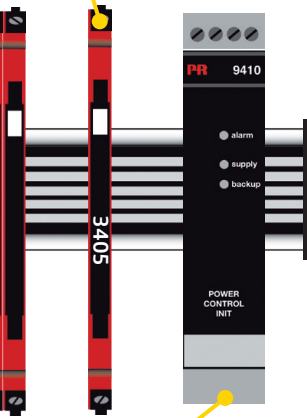

Protective fuse: Located inside the PR 9410.

## Power rail solution #3:

The PR 9410 power control unit can energize and power 96 W to the rail. Redundant power supplies are possible.

## Note:

3225-N can only be supplied via the DIN rail solution with direct wiring on each device.

## External fuse characteristics:

The 2.5 A fuse must break after not more than 120 seconds at 6.4 A.



# Universal frequency converter

## 3225

- Input: NAMUR, NPN, PNP, Tacho, TTL & S0
- Output: Universal mA / V or relay
- 2.5 KVAC isolation
- DIP-switch or display programmable
- Power supply 16.8 VDC...31.2 VDC

### Functional highlights

- Measures frequencies up to 100 kHz.
- Active current output.
- Buffered voltage output 10 VDC.
- Linearization: Linear or square root function.
- 2-point process calibration.
- User-programmable trigger levels -0.05...6.5 V and sensor supply 5...17 V.
- NAMUR sensor error detection.
- Advanced configurable input limits for increased safety.
- Output relay with windows, setpoint and latch functionality.
- Simulation of process value during commissioning / maintenance.
- Fast response time, with simultaneous sensor error detection (PATENTED).
- All terminals are over-voltage protected, polarity protected and short-circuit protected.

### Technical highlights

- Accuracy < 0.06% / span.
- Temperature coefficient 0.006% / °C.
- Response time < 30 ms.
- 2.5 kVAC, 3-port galvanic isolation.
- Wide ambient temperature range -25...70°C.
- NAMUR NE21, NE43.

### Programming

- Easy configuration via DIP switches.
- Factory calibrated in all selectable measurement ranges.
- Configuration, monitoring, and diagnostics using PR 4500 detachable communication interfaces via the PR 4590 ConfigMate.
- All programming can be password protected.
- Scrolling help text in 7 languages.

### Mounting

- Units can be mounted side by side, horizontally and vertically, without air gap on a standard DIN rail, even at 70°C ambient temperature.
- Units can be supplied separately or installed on PR 9400 power rail.
- The narrow 6.1 mm housing allows up to 163 units per meter.

# Connections

## 3225A

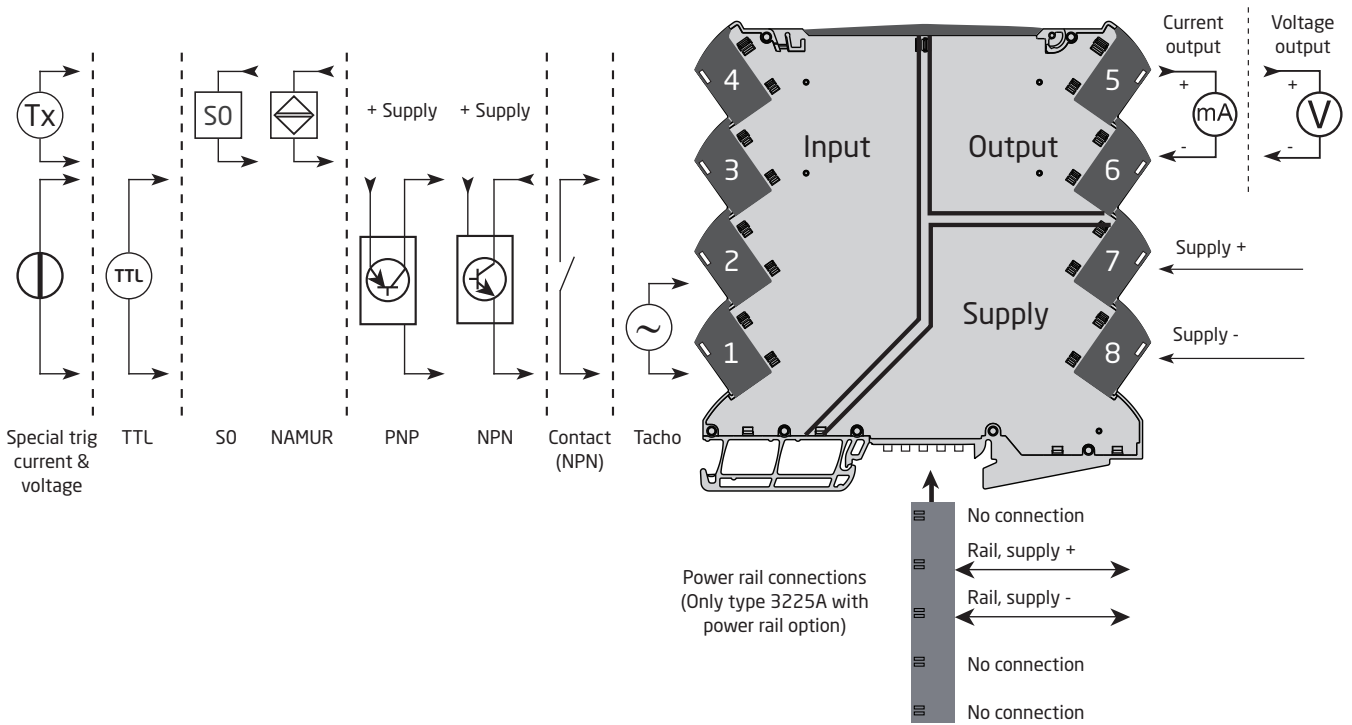

## 3225B

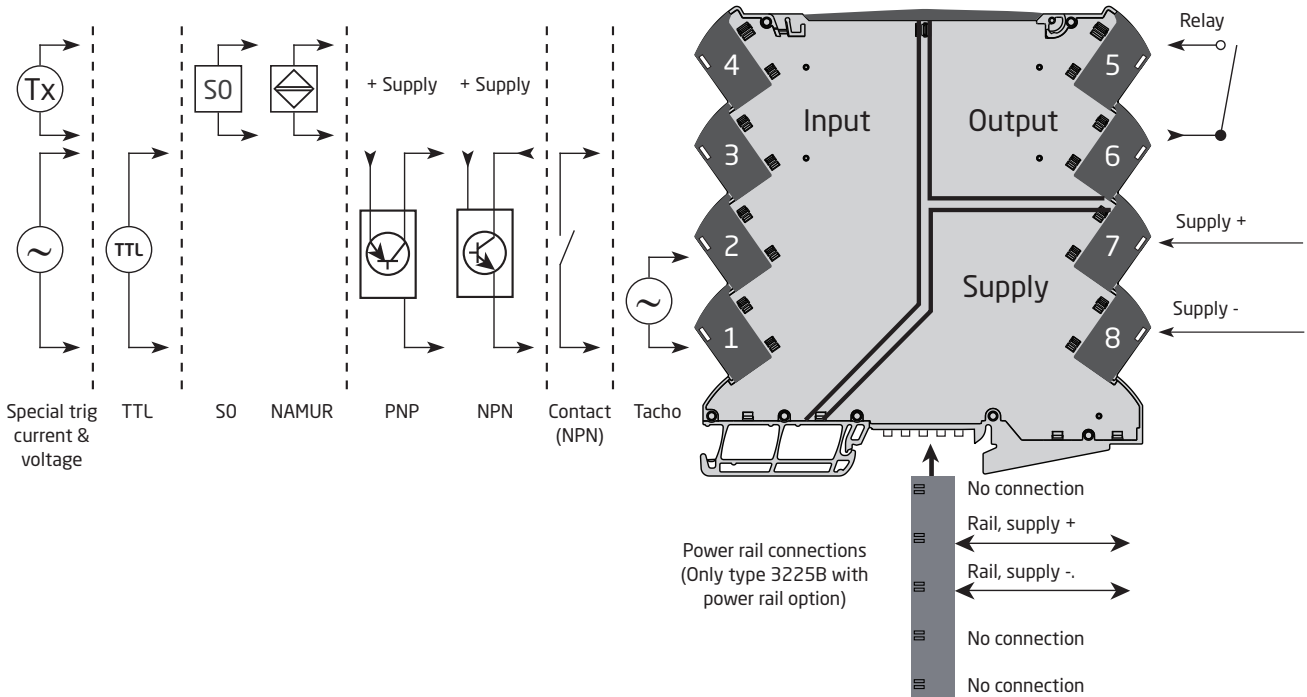



# Specifications

## Order

Type	Version		
3225	Universal frequency converter , analog output	: A	With power rail connector / terminals : -
	Universal frequency converter, alarm relay output	: B	Supplied via terminals : -N

Example: 3225B-N (Universal frequency converter, alarm relay output, supplied via terminals)

## Accessories

- 4510 = Display / programming front
- 4511 = Modbus communication enabler\*
- 4512 = Bluetooth communication enabler\*
- 4590 = ConfigMate
- 9404 = Module stop for rail

\*Note: PR 4511 and PR 4512 communication interfaces support display programming only. Modbus communication, Bluetooth and datalogging are not supported. PR 4512 requires PR 4590 ConfigMate with serial number > 211394001.

## Accessories for power rail devices

- 3405 = Power rail connector unit
- 9400 = Power rail - 7.5 or 15 mm high
- 9410 = Power control unit
- 9421 = Power supply

## Technical characteristics

### Environmental conditions

- Operating temperature . . . . . -25°C to +70°C
- Storage temperature . . . . . -40°C to +85°C
- Calibration temperature. . . . . 20...28°C
- Relative humidity . . . . . < 95% RH (non-cond.)
- Protection degree . . . . . IP20
- Installation in pollution degree 2 & measurement / overvoltage category II.

### Mechanical specifications

- Dimensions (HxWxD) . . . . . 113 x 6.1 x 115 mm
- Weight approx., 3225A / 3225B. . . . . 70 g / 70 g
- DIN rail type. . . . . DIN EN 60715 - 35 mm
- Wire size. . . . . 0.13...2.5 mm<sup>2</sup> / AWG 26...12 stranded wire
- Screw terminal torque. . . . . 0.5 Nm

### Common electrical specifications

- Supply voltage . . . . . 16.8...31.2 VDC
- Protective fuse. . . . . 400 mA SB / 250 VAC

Type	Max. power dissipation	Max. required power
3225A	≤ 0.65 W	≤ 1.2 W
3225B	≤ 0.65 W	≤ 1.2 W

Isolation - test . . . . . 2,5 kVAC  
 Isolation - working . . . . . 300 VAC reinforced  
 Signal dynamics, output . . . . . 18 bit  
 Response time (0...90%, 100...10%) . . . . .  $\leq 30$  ms  
 Long term stability, current, 1yr / 5yr @ 25 °C . . . . .  $\leq 0.058\%$  /  $\leq 0.101\%$   
 Long term stability, voltage, 1yr / 5yr @ 25 °C . . . . .  $\leq 0.032\%$  /  $\leq 0.058\%$

**Auxiliary supply**

Sensor supply limitation . . . . . 23 mA, 5...17 V

**Accuracy**

Accuracy, the greater of basic and absolute values:

**Input accuracy**

General values			
Input type	Range(s)	Absolute accuracy	Temperature coefficient
Frequency input	0 - 100 kHz	$\leq \pm 0.01\%$ of input frequency	$\leq \pm 0.0005\%$ / °C

Basic values			
Input type	Range(s)	Basic accuracy	Temperature coefficient
Frequency input	0 - 100 kHz	$\leq 0.0002$ Hz	$\leq \pm 0.0005\%$ / °C

**Output accuracy**

General values			
Output type	Range(s)	Absolute accuracy	Temperature coefficient
Current output	0 - 23 mA	$\leq \pm 0.05\%$ of span	$\leq \pm 0.005\%$ / °C
Voltage output	0 - 10 V	$\leq \pm 0.05\%$ of span	$\leq \pm 0.005\%$ / °C

Basic values			
Output type	Range(s)	Basic accuracy	Temperature coefficient
Current output	0 - 23 mA	8 $\mu$ A	0.8 $\mu$ A / °C
Voltage output	0 - 10 V	2 mV	200 $\mu$ V / °C

EMC - immunity influence. . . . .	$< \pm 0.5\%$ of span
Extended EMC immunity: NAMUR NE 21, A criterion, burst . . . . .	$< \pm 1\%$ of span

of span = of selected standard range

## Input specifications

### Frequency input

Frequency range . . . . .	0.001 Hz to 100 kHz
Time range, time function . . . . .	10 $\mu$ s to 999.9 s
Max. frequency, with input filter ON . . . . .	75 Hz
Min. pulse width with input filter ON . . . . .	8 ms
Min. pulse width with input filter OFF . . . . .	4 $\mu$ s
Response time (0...90%, 100...10%) . . . . .	< 30 ms

### Tacho input

Trig-level LOW . . . . .	$\leq$ -50 mV
Trig-level HIGH . . . . .	$\geq$ +50 mV
Input impedance . . . . .	100 k $\Omega$    < 220 pF
Max. input voltage . . . . .	80 VAC pp

### NPN / PNP input

Trig-level LOW . . . . .	$\leq$ 4.0 V
Trig-level HIGH . . . . .	$\geq$ 7.0 V
Input impedance . . . . .	3.48 k $\Omega$    < 220 pF
Trigger edge . . . . .	NPN = Neg. edge, PNP = Pos. edge.
Sensor supply . . . . .	5...17 V / 23 mA

### TTL input

Trig-level LOW . . . . .	$\leq$ 0.8 V
Trig-level HIGH . . . . .	$\geq$ 2.0 V
Input impedance . . . . .	$\geq$ 100 k $\Omega$    < 220 pF
Sensor supply . . . . .	5...17 V / 23 mA

### S0 input acc. to DIN 43864

Trig-level LOW . . . . .	$\leq$ 2.2 mA
Trig-level HIGH . . . . .	$\geq$ 9.0 mA
Input impedance . . . . .	758 $\Omega$    < 220 pF
Sensor supply . . . . .	17 V / 23 mA

### NAMUR input

NAMUR according to . . . . .	EN 60947-5-6
Trig-level LOW . . . . .	$\leq$ 1.2 mA
Trig-level HIGH . . . . .	$\geq$ 2.1 mA
Input impedance . . . . .	1 k $\Omega$    < 220 pF
Breakage detection . . . . .	$\leq$ 0.1 mA
Short-circuit detection . . . . .	$\geq$ 6.9 mA
Sensor supply . . . . .	8.3 V

### Special voltage input

User-programmable trig-levels . . . . .	-0.05...6.50 V
*Hysteresis, min. . . . .	50 mV
Input impedance, programmable:	
High Z . . . . .	$\geq$ 100 k $\Omega$    < 220 pF
Pull up/down . . . . .	3.48 k $\Omega$    < 220 pF
Sensor supply . . . . .	5...17 V / 23 mA
Max. input voltage . . . . .	17 V

### Special current input

User-programmable trig-levels . . . . .	0.0...10.0 mA
*Hysteresis, min. . . . .	0.2 mA
Input impedance . . . . .	1 k $\Omega$    < 220 pF
Sensor supply . . . . .	5...17 V / 23 mA
Max. input current . . . . .	17 mA

\* For low signal levels with input trigger level hysteresis below 100 mV / 0.1 mA it is recommended to use shielded cables with correct grounding, to avoid false triggering due to induced EMC.

### Configurable input limits

Error detection . . . . .	Enable / disable
Configurable input limits, low . . . . .	0 Hz...min. configured input frequency
Configurable input limits, high . . . . .	Max. configured input frequency...100 kHz
Hysteresis. . . . .	0.5% of max. configured input frequency
Input limit low/high, error indication levels . . . . .	UP, DOWN, ZERO, NONE
	See tables on page 21

### Output specifications

#### Current output

Signal range, active . . . . .	0...23 mA
Programmable standard ranges . . . . .	0...20 / 4...20 mA
Load, max.. . . . .	23 mA / 600 $\Omega$
Load stability . . . . .	$\leq 0.01\%$ of span / 100 $\Omega$
Response time, programmable. . . . .	0...60 s
Sensor error detection . . . . .	0 / 3.5 / 23 mA / none
Input limiters, error indication levels . . . . .	See tables on page 21
Current limit. . . . .	$\leq 28$ mA

#### Voltage output

Signal range. . . . .	$\leq 11.5$ VDC
Programmable standard ranges . . . . .	0...1, 0...5, 0...10, 0.2...1, 2...10 VDC
Load, min. . . . .	$> 10$ k $\Omega$
Response time, programmable. . . . .	0...60 s
Input limiters, error indication levels . . . . .	See tables on page 21

#### Relay output

Relay functions. . . . .	Setpoint, Window and Latch
Hysteresis, in % of span / display range . . . . .	0...100%
On and Off delay . . . . .	0...3600 s
Power on delay. . . . .	0...9999 s
Sensor error reaction . . . . .	Break / Make / Hold
Max. voltage . . . . .	250 VAC / 200 VDC
Max. AC current. . . . .	2 A
Max. AC power . . . . .	500 VA
Max. DC current, resistive load:	
@ $U_{\text{relay}} \leq 30$ VDC . . . . .	2 ADC
@ $30$ VDC $< U_{\text{relay}} < 200$ VDC . . . . .	$380 \times (U_{\text{relay}} - 15)^2 \times 1.012^{U_{\text{relay}} - 15}$ ADC

Graphic depiction of  $380 \times (U_{\text{relay}} - 15)^{-2} \times 1.012^{U_{\text{relay}} - 15}$ ;

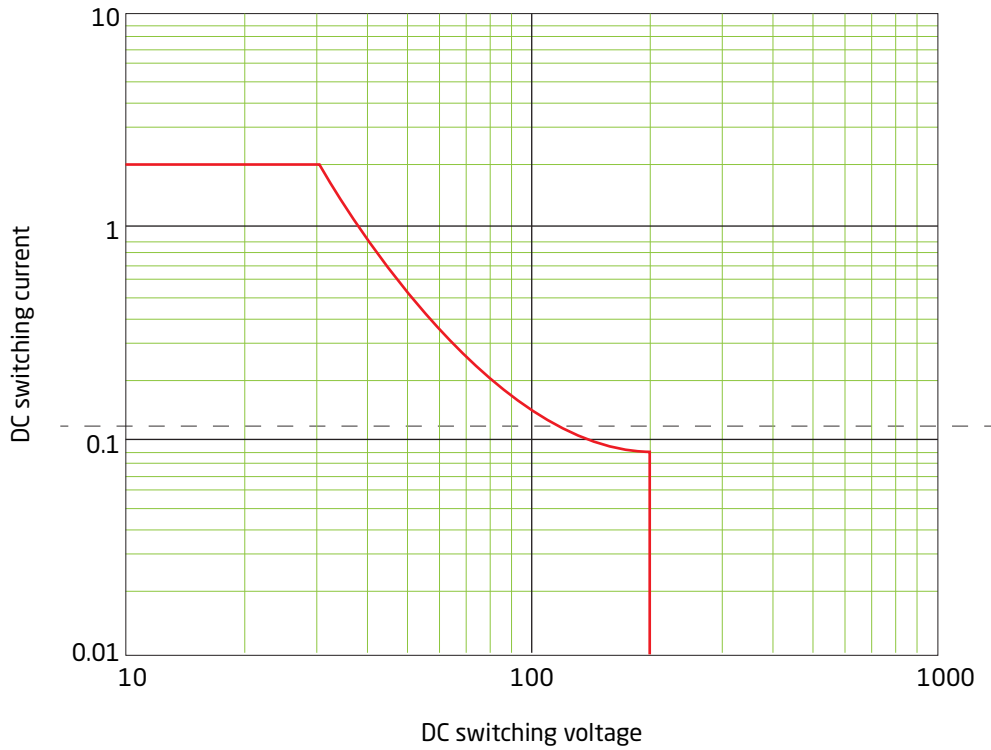

**Observed authority requirements**

EMC . . . . .	2014/30/EU & UK SI 2016/1091
LVD . . . . .	2014/35/EU & UK SI 2016/1101
RoHS . . . . .	2011/65/EU & UK SI 2012/3032
ATEX . . . . .	2014/34/EU & UK SI 2016/1107

**Approvals**

c UL us, UL 61010-1. . . . .	E314307
Safe Isolation. . . . .	EN 61140

**Ex approvals:**

ATEX . . . . .	KEMA 10ATEX0147 X
IECEX. . . . .	KEM 10.0068 X
UKEX. . . . .	DEKRA 21UKEX0055X



# Programming

## DIP-switch configuration

Applicable devices can be configured via DIP-switches. The DIP-switches are located on the side of the device and can be adjusted with a small screwdriver or other implement.

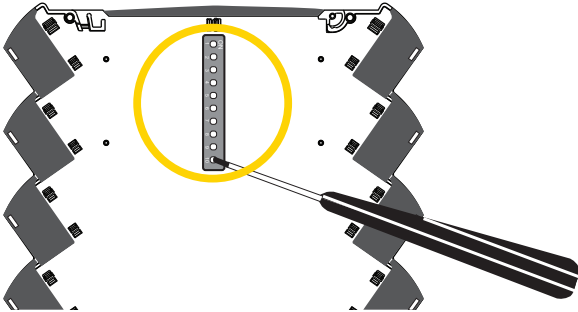

Default factory settings (with all DIP-switches in the OFF position):

Type	Display text	Parameter text	3225A	3225B
Sensor	Z.IN	Input impedance	HI.Z	HI.Z
Input	iN.LO	Input range low	0	0
	FILTER	Input filter > 75 Hz	DIP-switch setting	Off
	OUT.RSP	Output response	0.0 s	n.a.
	POW.DEL	Power on delay	0 s	n.a.
Relay	R1.FUNC	Relay function	n.a.	SETP
	ERR.ACT	Error action	n.a.	NONE
	ON.DEL	On delay	n.a.	0 s
	OFF.DEL	Off delay	n.a.	0 s
	R1.LATC	Enable latch	n.a.	NO
Calibration	USE.CAL	Use calibration	NO	NO

Enabling DIP-switch programming disables PR 4500 communication interface programming, maintaining the ability to cycle through the menu on the display and verify parameter values and device status. For DIP-switch programming, the non DIP-switch programmable parameters are set at factory default values.

## Calculating DIP-switch settings for Input high or setpoint settings

Calculating the decimal value from the binary setting, you derive F1 from S2.1-7 and the multiplication factor F2 from S2.8-10, and you get:

$$F_{\text{setpoint/input high}} = F_1 * F_2$$

Note: The maximum input frequency is 100,000 Hz.

Valid configuration e.g. base value = 80 and multiplier = 1000 => 80,000 Hz.

Invalid configuration e.g. base value = 127 and multiplier 1000 => 127,000 Hz.

The PR 4590 can power the PR 3225 for programming mode only. Neither the input nor the output is active in programming mode (powered by PR 4590). Remember to cycle power for both power rail / terminals and PR 4590 (if present) to reload DIP-switch values at power up.

When DIP-switch S1.10 = ON, the PR 3225 will load the last saved configuration during the power-up sequence. PR 3225 is shipped from factory with all DIP-switches set to off, which selects default configuration.

## DIP-switch settings 3225A

Input types		Sensor supply S1			1		2		3	
NAMUR without sensor error det.	8,3V									●
NAMUR with sensor error det.	8,3V									●
NPN	17V									●
PNP	17V									●
Tacho	17V									●
TTL	5V									●
S0	17V									●

Output types		S1		4		5		6	
0...20mA									
4...20mA									●
0...1V									●
0.2...1V									●
0...10V									●
2...10V									●
0...5V									●
1...5V									●

Frequency input max. (f high)		S2		1		2		3		4		5		6		7		f2 [x factor]		S2		8		9		10	
1																		0,001									
2																		0,01									●
4																		0,1									●
8																		1									●
16																		10									●
32																		100									●
64																		1.000									●
																		10.000									●

Input filter		S1		7		
On						●
Off						

Output error level		S1		8		
Downscale						
Upscale						●

Low cut off		S1		9		
On						●
Off						

Configuration		S1		10		
DIP						
4590						●

●= ON  $f1=S2.1+S2.2+S2.3+S2.4+S2.5+S2.6+S2.7$   
 $f\ high = f1xf2$

## DIP-switch settings 3225B

Input types		Sensor supply S1			1		2		3	
NAMUR without sensor error det.	8,3V									●
NAMUR with sensor error det. *	8,3V									●
NPN	17V									●
PNP	17V									●
Tacho	17V									●
TTL	5V									●
S0	17V									●

Relay contact		S1		4		
N.O.						
N.C.						●

Activation direction		S1		5		
Increasing						
Decreasing						●

Hysteresis		S1		6		7	
1%							
5%							●
10%							●
25%							●

Power on delay		S1		8		
2 sec.						
120 sec.						●

Relay activation delay		S1		9		
0 sec.						
10 sec.						●

Configuration		S1		10		
DIP						
4590						●

\* : Action on error is "OPEN"

Relay setpoint (f setpoint)		S2		1		2		3		4		5		6		7		f2 [x factor]		S2		8		9		10	
1																		0,001									
2																		0,01								●	
4																		0,1								●	
8																		1								●	
16																		10								●	
32																		100								●	
64																		1.000								●	
																		10.000								●	

●= ON  $f1=S2.1+S2.2+S2.3+S2.4+S2.5+S2.6+S2.7$   
 $f\ setpoint = f1xf2$

For easy DIP-switch programming, our DIP-switch configurator can be found at:  
[www.prelectronics.com/dip-switch-configurator/](http://www.prelectronics.com/dip-switch-configurator/)

## PR 4590 ConfigMate programming

Connect the adapter by opening the front plate on PR 3225 and inserting the jack into the plug.



A reference for the complete menu structure and programming options can be found in the section 'Routing diagram' on page 28. For further information on how to navigate and operate the PR 4500 communication interfaces, please refer to [www.prelectronics.com/4500/](http://www.prelectronics.com/4500/).

# Configurable input error indication and input limits

## Configurable input error detection

To increase system safety and integrity, you can program a high and low input error detection level. Input signals outside the low and high limits will cause the output of the device to go to the programmed error state.

The two configurable input error detection levels can be set and enabled individually, just as it is possible to individually set the output error indication for each of the two detection levels. This allows users to differentiate process faults, broken or short input wires.

Available output error states for low and high limit: UP, DOWN, ZERO and NONE.

Output error indication uses the error states defined by NAMUR NE43 for a 4...20 mA output span. For all other output spans equivalent output error indications are used (see tables on page 21).

When input limit is enabled and error state NONE is selected, the input error is detected and presented to you on the display with IN.ER and flashing display, but not indicated on the output signal.

Example – 4...20 mA output span and both Limit high and Limit low set to ZERO

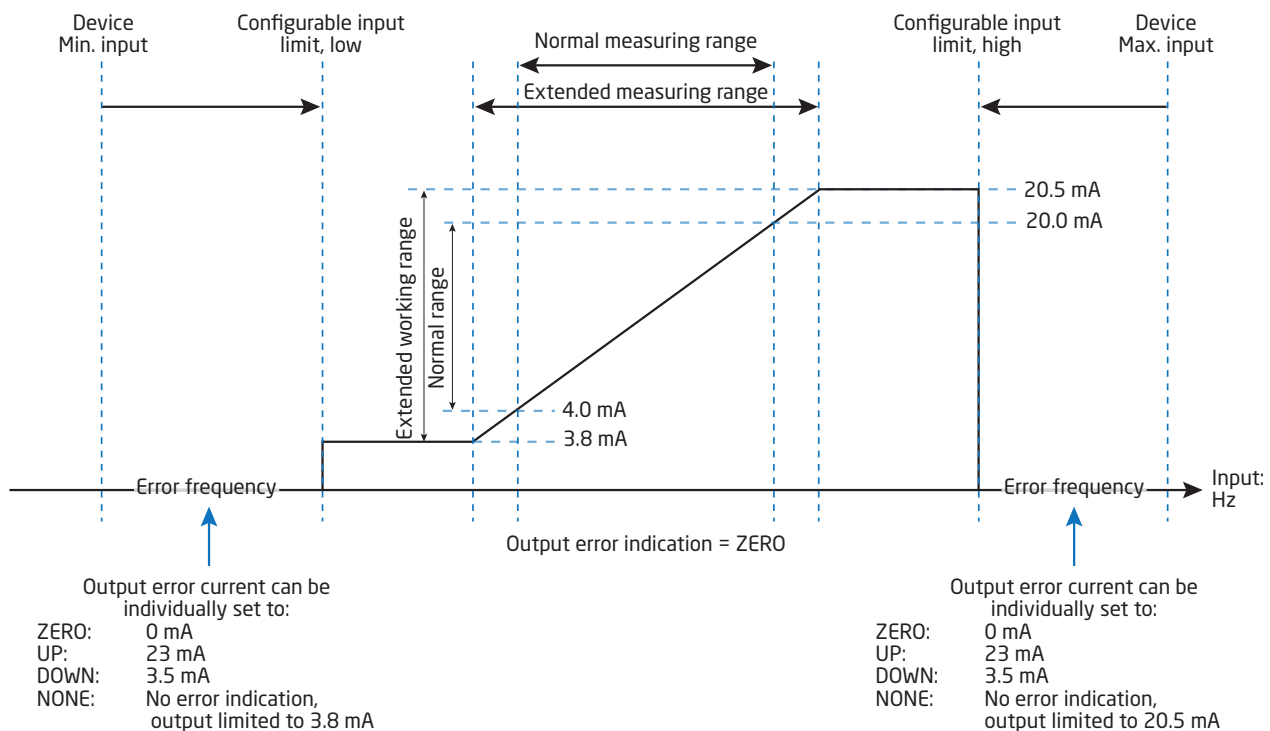

### Example - Input limits disabled

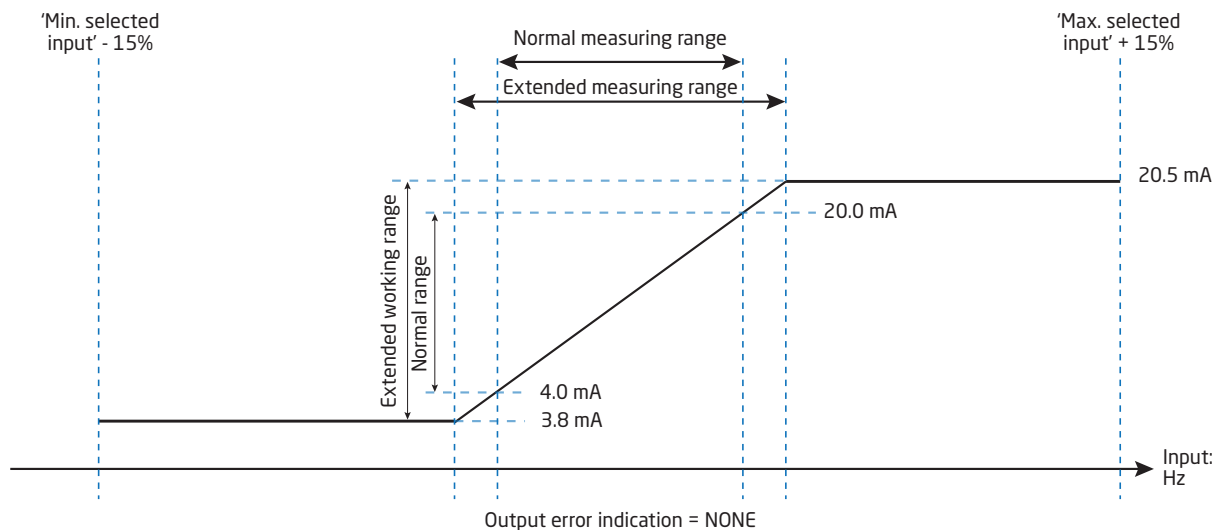

### Output limits and error indications - current output

Output span	Input limit disabled		NAMUR sensor error detection / input limit enabled					
	Output limit low	Output limit high	Output limit low	Output limit high	Output error indication, UP	Output error indication, DOWN	Output error indication, ZERO	Output error indication, NONE
4-20 mA	0 mA	23 mA	3.8 mA	20.5 mA	23 mA	3.5 mA	0 mA	No error indication
0-20 mA	0 mA	23 mA	0 mA	20.5 mA	23 mA	0 mA	0 mA	No error indication

### Output limits and error indications - voltage output

Output span	Input limit disabled		NAMUR sensor error detection / input limit enabled					
	Output limit low	Output limit high	Output limit low	Output limit high	Output error indication, UP	Output error indication, DOWN	Output error indication, ZERO	Output error indication, NONE
0-1 V	0 V	1.15 V	0 V	1.025 V	1.15 V	0 V	0 V	No error indication
0.2-1 V	0 V	1.15 V	0.19 V	1.025 V	1.15 V	0.175 V	0 V	No error indication
0-5 V	0 V	5.75 V	0 V	5.125 V	5.75 V	0 V	0 V	No error indication
1-5 V	0 V	5.75 V	0.975 V	5.125 V	5.75 V	0.875 V	0 V	No error indication
0-10 V	0 V	11.5 V	0 V	10.25 V	11.5 V	0 V	0 V	No error indication
2-10 V	0 V	11.5 V	1.95 V	10.25 V	11.5 V	1.75 V	0 V	No error indication

## Low cut-off function

Default configured for 1111 s (0.0009 Hz) or 2 s (0.5 Hz) with L.COF enabled. Drives input to 0 Hz when Low Cut-Off time is reached.

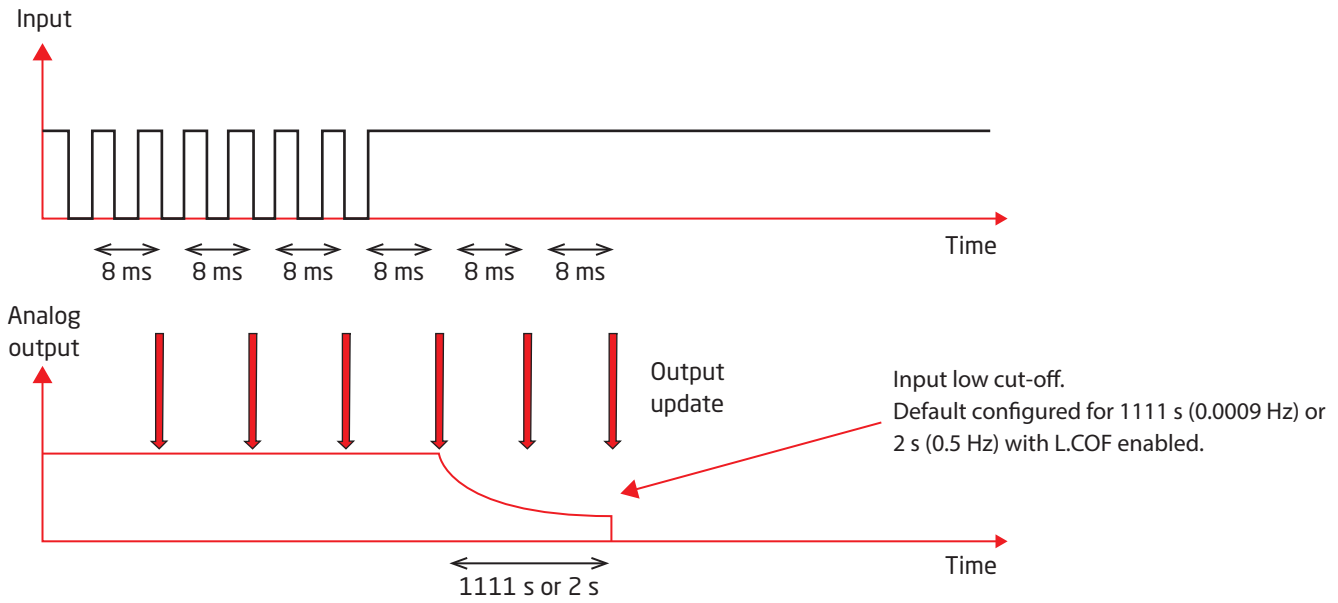

## Square root function

A Square root function can be applied to the input. Scaling of the function can be done as illustrated below:

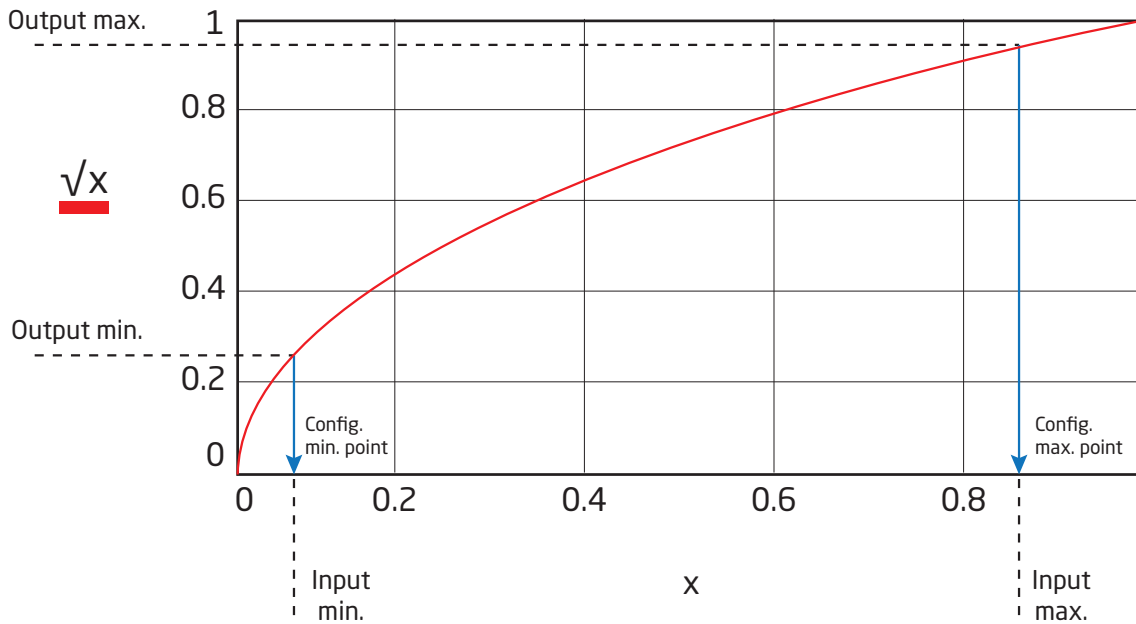

### Low cut-off function:

As a part of the square root function of the PR 3225 it is possible to manually configure a low cut-off point. The feature is often used to suppress noise in the system. The low cut off point defines a point where the input/output relationship either changes to a linear relationship or the output is truncated to zero. The two principles are illustrated below:

### Linear cut-off:

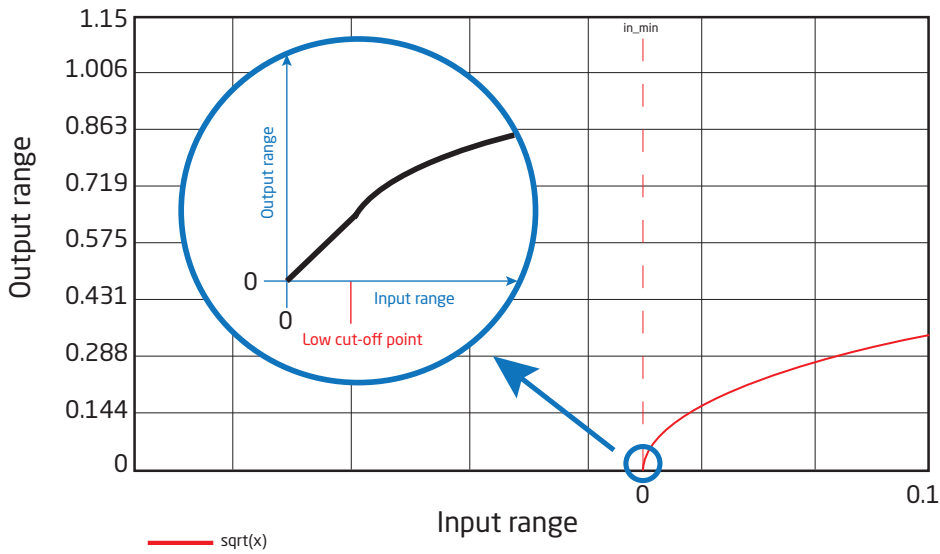

### Truncation to zero:

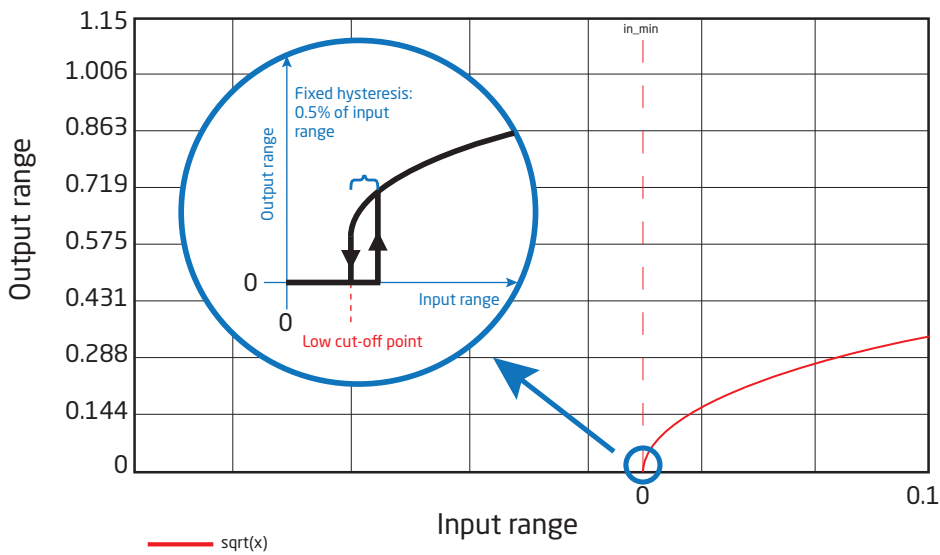

Configuration	Parameter	Specification	Condition
Low cut-off point	Linear cut-off	0.0 to 50.0% of selected input range	Independent of square root settings
	Truncation to zero	0.0 to 50.0% of selected input range Fixed hysteresis of 0.5% of the selected input range	

**Over range / under range operation:**

Configuration	Parameter	Specification	Condition
Normal square root action	Input low limit	'Minimum of selected input range'	'Square root point max.'
	Input high limit	'Maximum of selected input range' + 20%	> 'Square root point min.'
Inverted square root operation	Input low limit	'Minimum of selected input range' - 20%	'Square root point max.'
	Input high limit	'Maximum of selected input range'	< 'Square root point min.'

## Relay functions 3225B

**3 different settings of relay function can be selected.**

- Setpoint: The device works as a single limit switch.  
Window: The relay has a window that is defined by a low and high setpoint. On both sides of the window the relay has the same status.  
Latch: The relay is latched. Valid for Setpoint and Window function (advanced settings).

### Setpoint and window configuration

Common parameters:

Delay: An ON and an OFF delay can be set on the relay in the range 0...3600 s.

Hysteresis: 0.0...100.0%.

An active relay can be set as either normally open or normally closed.

The device works as a single limit switch when selecting 'setpoint' in the menu and entering the desired limit. For setpoint the relay can be set to activate on increasing or decreasing input signal.

The window function is selected by choosing 'window' in the menu and defining a high and a low setpoint. The relay can be configured as active inside the window or outside the window.



### Graphic depiction of relay action setpoint

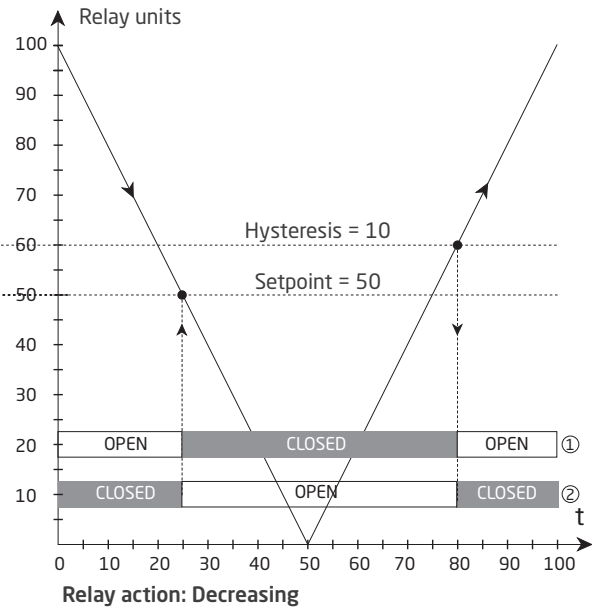
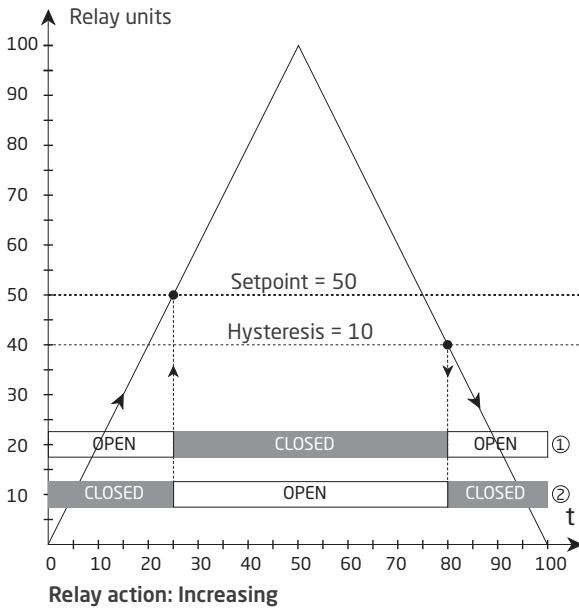

- ① = Normal function. Relay configured for N.O.
- ② = Inverse function. Relay configured for N.C.

### Graphic depiction of relay action window

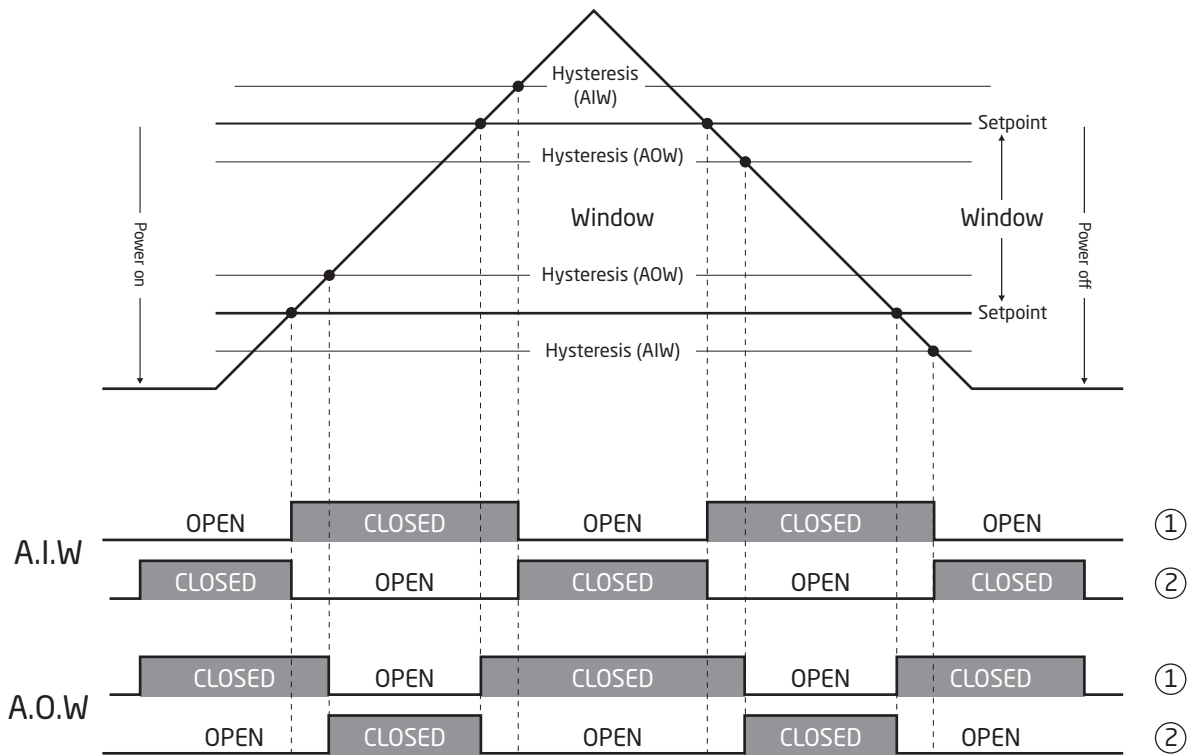

### Relay function: Active Inside Window / Active Outside Window

- ① = Normal function. Relay configured for N.O.
- ② = Inverse function. Relay configured for N.C.

# Graphic depiction of latch function window

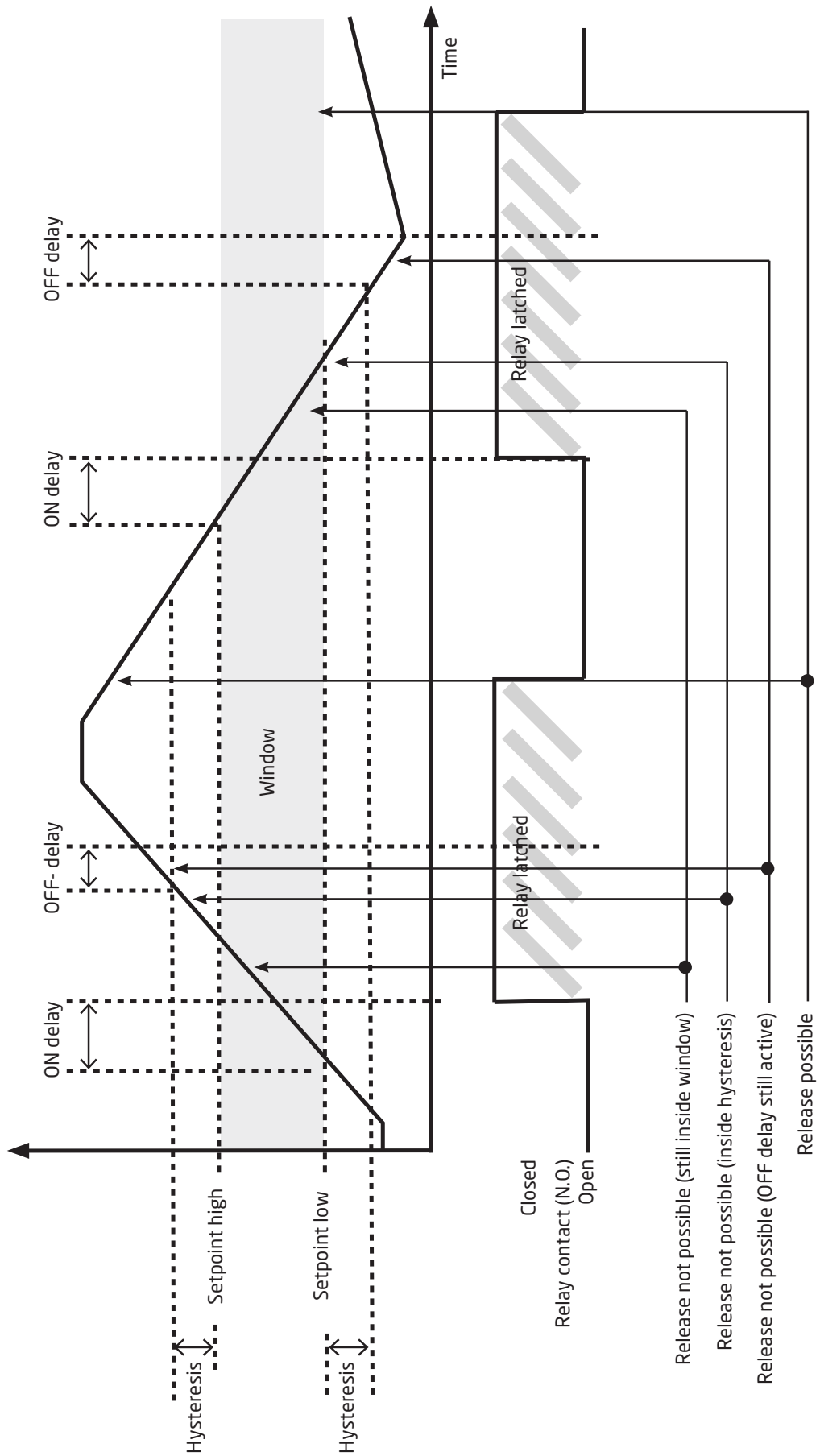

## Advanced settings menu

**Password protection (PASS):** Programming access can be blocked by assigning a password. The password is saved in the device in order to ensure a high degree of protection against unauthorized modifications to the configuration. If the configured password is not known, please contact PR electronics support - [www.prelectronics.com/contact](http://www.prelectronics.com/contact).

**Memory (MEM):** In the memory menu you can save the configuration of the device in the PR 4500 communication interface, and then move the PR 4500 communication interface onto another device of the same type and download the configuration in the new device.

**Display setup (DISP):** Here you can adjust the brightness contrast and the backlight. Setup of TAG numbers with 6 alphanumeric. Selection of functional readout in line 3 of the display - choose between readout of analog output or tag no.

**Two-point process calibration (CAL):** The device can be process-calibrated in 2 points to fit a given input signal. A low input signal (not necessarily 0%) is applied and the actual value is entered via the PR 4500 communication interface. Then a high signal (not necessarily 100%) is applied and the actual value is entered via the PR 4500 communication interface. If you accept to use the calibration, the device will work according to this new adjustment. If you later reject this menu point or choose another type of input signal the device will return to factory calibration. Process-calibration is cleared if you edit either of the parameters: input type, input low, input high, display low or display high. Process calibration data are not saved to the configuration repository of the PR 4500 communication interface.

**Process simulation function (SIM):** Simulation of process value is possible via the up and down arrows, thus controlling the output signal. The point REL.SIM allows you to activate relay/-s by means of the arrow-keys up/down. You must exit the menu by pressing  (no time-out). The simulation function exits automatically if the PR 4500 communication interface is detached.

**Latch function (LATC):** A latch function can be applied for a relay when combined with the setpoint, window or error function. The latch function will hold the relay in its active/alarm state until latch is released via the PR 4500 display. If the setpoint, window or error function demands an active relay you cannot release the latch. If the configuration is copied from one device to another by way of the PR 4500 communication interface, the latch function must be reconfigured.

# Routing diagram - 3225A

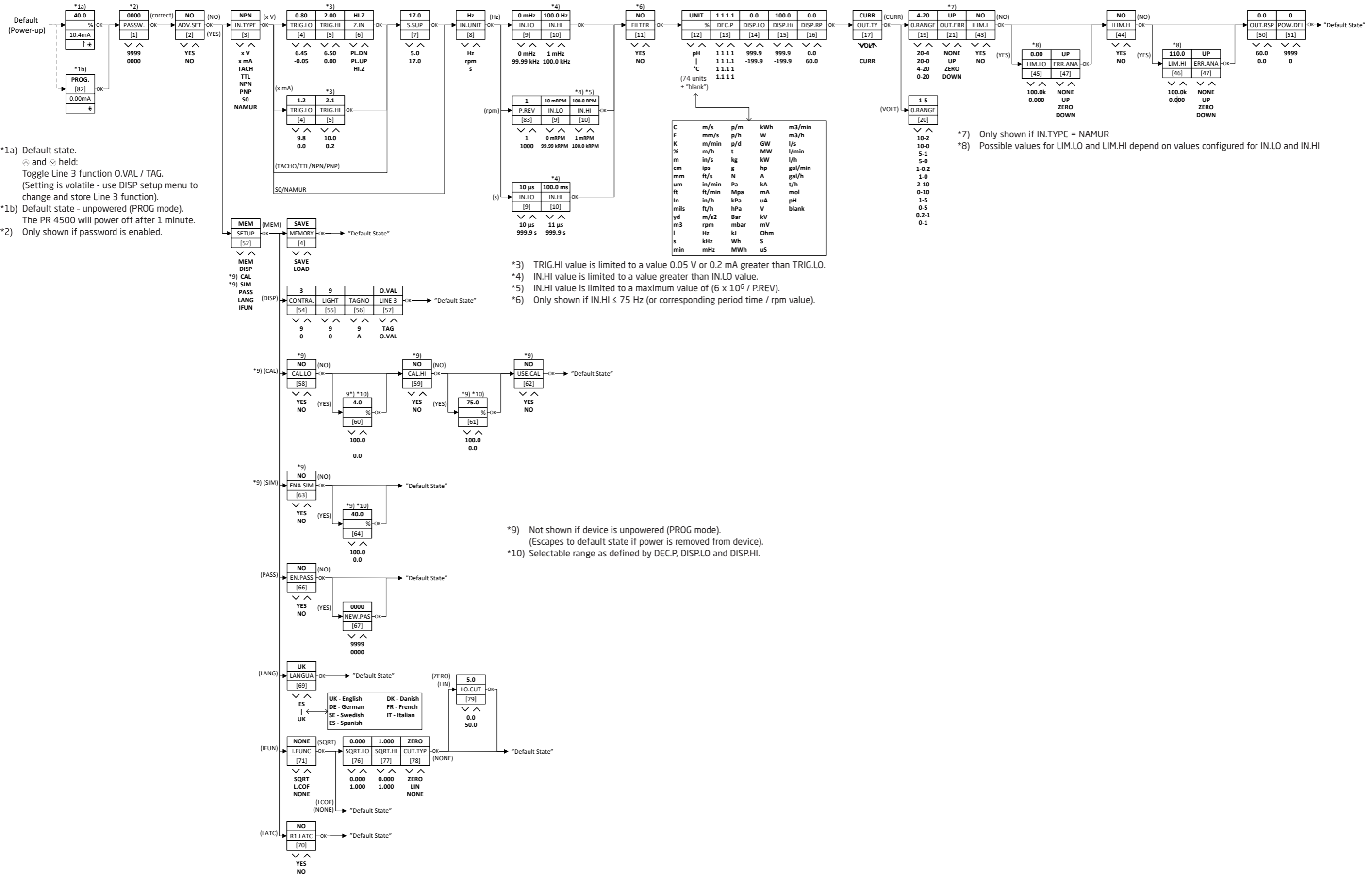

- \*1a) Default state.  
 ^ and v held:  
 Toggle Line 3 function O.VAL / TAG.  
 (Setting is volatile - use DISP setup menu to change and store Line 3 function).
- \*1b) Default state - unpowered (PROG mode).  
 The PR 4500 will power off after 1 minute.
- \*2) Only shown if password is enabled.

- \*3) TRIG.HI value is limited to a value 0.05 V or 0.2 mA greater than TRIG.LO.
- \*4) IN.HI value is limited to a value greater than IN.LO value.
- \*5) IN.HI value is limited to a maximum value of  $(6 \times 10^6 / P.REV)$ .
- \*6) Only shown if  $IN.HI \leq 75$  Hz (or corresponding period time / rpm value).

- \*7) Only shown if IN.TYPE = NAMUR
- \*8) Possible values for LIM.LO and LIM.HI depend on values configured for IN.LO and IN.HI

- \*9) Not shown if device is unpowered (PROG mode).  
 (Escapes to default state if power is removed from device).
- \*10) Selectable range as defined by DEC.P, DISP.LO and DISP.HI.

# Routing diagram - 3225B

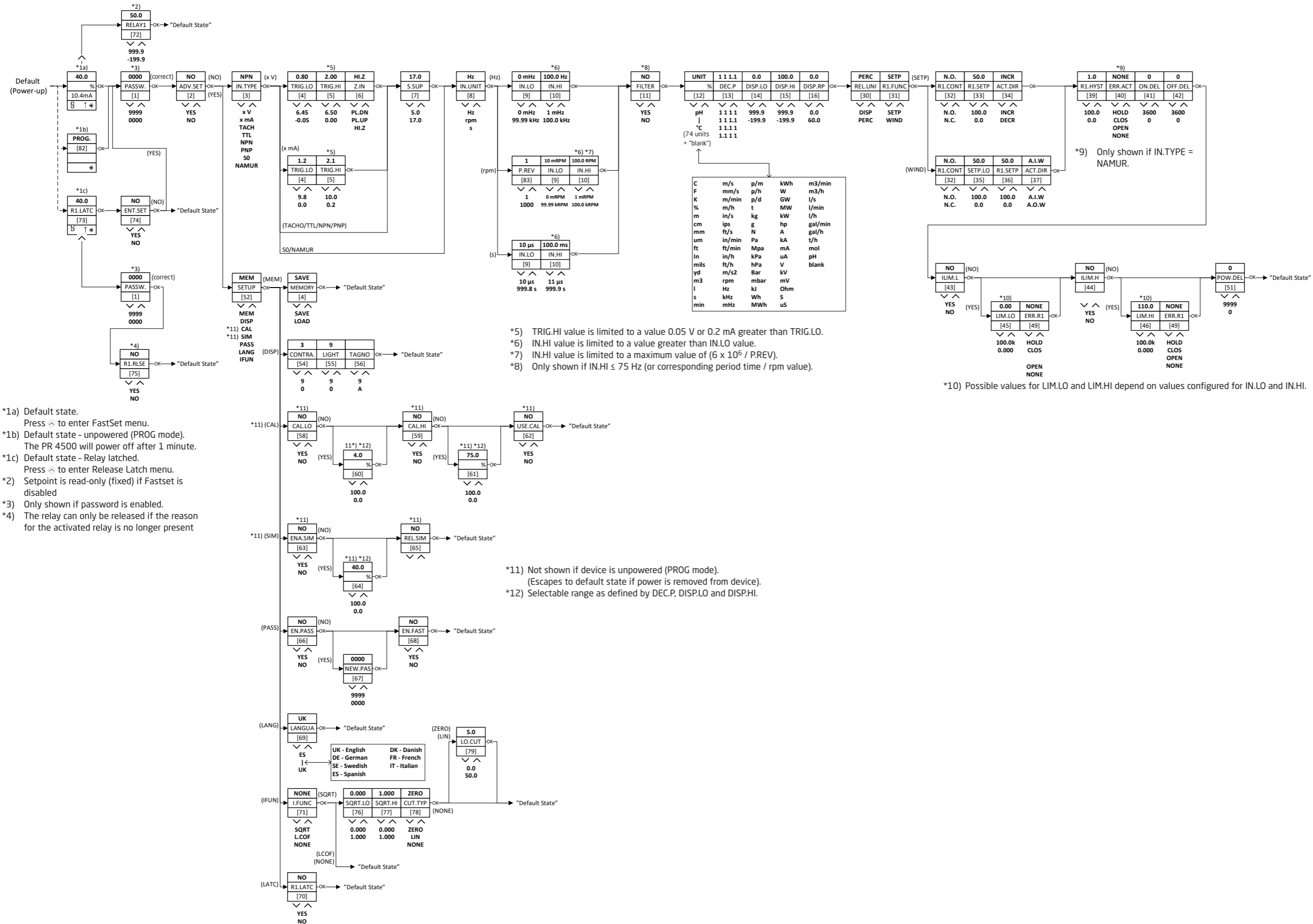

- \*1a) Default state. Press  $\Delta$  to enter FastSet menu.
- \*1b) Default state - unpowered (PROG mode). The PR 4500 will power off after 1 minute.
- \*1c) Default state - Relay latched. Press  $\Delta$  to enter Release Latch menu.
- \*2) Setpoint is read-only (fixed) if Fastset is disabled
- \*3) Only shown if password is enabled.
- \*4) The relay can only be released if the reason for the activated relay is no longer present

- \*5) TRIG.HI value is limited to a value 0.05 V or 0.2 mA greater than TRIG.LO.
- \*6) IN.HI value is limited to a value greater than IN.LO value.
- \*7) IN.HI value is limited to a maximum value of  $(6 \times 10^6 / P.REV)$ .
- \*8) Only shown if  $IN.HI \leq 75$  Hz (or corresponding period time / rpm value).

- \*11) Not shown if device is unpowered (PROG mode). (Escapes to default state if power is removed from device).
- \*12) Selectable range as defined by DEC.P, DISP.LO and DISP.HI.

\*10) Possible values for LIM.LO and LIM.HI depend on values configured for IN.LO and IN.HI.

## Help text overview

- [1] Set correct password
- [2] Enter advanced setup menu?
- [3] Select NAMUR sensor input  
Select SO sensor input  
Select PNP sensor input (or Contact to supply)  
Select NPN sensor input (or Contact to ground)  
Select TTL sensor input  
Select Tacho sensor input  
Select custom current trigger input  
Select custom voltage trigger input
- [4] Set low trigger level for input signal
- [5] Set high trigger level for input signal
- [6] Set input high impedance (high resistance)  
Enable internal pull-up on input  
Enable internal pull-down on input
- [7] Set sensor supply voltage
- [8] Set up input for period time measurement  
Set up input for rpm measurement  
Set up input for frequency measurement
- [9] Set input range, low
- [10] Set input range, high
- [11] Enable input filter (50/60 Hz low-pass / BW-limiter)
- [12] Select display unit
- [13] Select decimal point position
- [14] Set display range, low
- [15] Set display range, high
- [16] Set display response time [seconds]
- [17] Set up output as current output  
Set up output as voltage output
- [19] Select 20..4 mA output range  
Select 20..0 mA output range  
Select 4..20 mA output range  
Select 0..20 mA output range
- [20] Select 10..2 V output range  
Select 10..0 V output range  
Select 5..1 V output range  
Select 5..0 V output range  
Select 1..0.2 V output range  
Select 1..0 V output range  
Select 2..10 V output range  
Select 0..10 V output range  
Select 1..5 V output range  
Select 0..5 V output range  
Select 0.2..1 V output range  
Select 0..1 V output range
- [21] Select output downscale at NAMUR sensor error  
Select output zero output at NAMUR sensor error  
Select output upscale at NAMUR sensor error  
Select no error action - output undefined - at NAMUR sensor error
- [30] Set up relay in % of input range  
Set up relay in display units
- [31] Select WINDOW function - relay is controlled by 2 setpoints  
Select SETPOINT function - relay is controlled by 1 setpoint
- [32] Select Normally Closed contact  
Select Normally Open contact
- [33] Set relay setpoint
- [34] Activate relay on decreasing signal  
Activate relay on increasing signal
- [35] Set relay window setpoint, low
- [36] Set relay window setpoint, high
- [37] Select relay to be Active Outside Window  
Select relay to be Active Inside Window
- [39] Set relay hysteresis
- [40] Select no error action - undefined relay state - at NAMUR sensor error  
Open relay contact at NAMUR sensor error  
Close relay contact at NAMUR sensor error  
Hold relay status at NAMUR sensor error
- [41] Set relay ON delay [seconds]
- [42] Set relay OFF delay [seconds]
- [43] Enable configurable input limit, low
- [44] Enable configurable input limit, high
- [45] Set configurable input limit, low
- [46] Set configurable input limit, high
- [47] Select downscale at limit error  
Select zero output at limit error  
Select upscale at limit error  
Select no error action - output undefined - at limit error
- [49] Select no error action - undefined relay state - at limit error  
Open relay contact at limit error  
Close relay contact at limit error  
Hold relay status at limit error
- [50] Set output response time [seconds]
- [51] Set output and relay power-on delay [seconds]
- [52] Enter Relay Latch setup  
Select Analog Input Function  
Enter Language setup  
Enter Password setup  
Enter Simulation mode  
Perform Process calibration  
Enter Display setup  
Perform Memory operations
- [53] Load saved configuration into module  
Save configuration in display front
- [54] Adjust LCD contrast
- [55] Adjust LCD backlight
- [56] Write a 6-character device TAG
- [57] Output value is shown in display line 3  
Device TAG is shown in display line 3

- [58] Calibrate Input low to process value?
- [59] Calibrate Input high to process value?
- [60] Set value for low calibration point
- [61] Set value for high calibration point
- [62] Use process calibration values?
- [63] Enable input simulation?
- [64] Set the input simulation value
- [65] Relay simulation - use ⏪ and ⏩ to toggle relay 1 and 2
- [66] Enable password protection?
- [67] Set new password
- [68] Enable Fastset functionality?
- [69] Select language
- [70] Enable Relay Latch function?
- [71] Select no input function  
     Select 0.5 Hz low cut off on input. (No effect on period  
     time input)  
     Select Square Root Input Function
- [72] Relay setpoint - press ⏹ to save  
     Relay setpoint - read only
- [73] Relay is latched - press ⏹ to acknowledge  
     Relay 1 is latched - press ⏪ to release
- [74] Enter setup menu? (Latched relay may release!)
- [75] Release relay? (if conditions allow)
- [76] Select low value of square root
- [77] Select high value of square root
- [78] Disable low cut-off  
     Set low cut-off type to linear  
     Set low cut-off type to zero
- [79] Select low cut-off point in % of input range
- [82] Programming mode only - no output signal
- [83] Set input pulses per revolution

## Operation & troubleshooting

The 3000 series devices provide multiple features for easy user operation and for performing efficient troubleshooting.

Monitoring the operational status is easy from either the front LEDs.

### Status indicators front LEDs

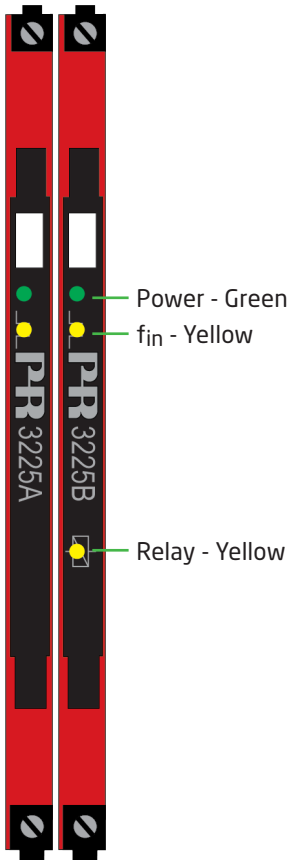

Indicator	Indicator pattern	Condition
Power	13 Hz, 250 ms	Normal operation
	1 Hz, 2 ms	Device OK, Sensor or Input limit error
	Solid	Internal error
	Solid	Device failure
f <sub>in</sub>	Input active or: input f > 13 Hz => 13 Hz, 250 ms	Signal > trigger level high
Relay	0...13 Hz, 20 ms < 250 ms	Relay energized



# Installation instructions

## UL installation

Use 60/75°C copper conductors only.

Wire size . . . . . AWG 26-12

UL file number . . . . . E314307

The device is an Open Type Listed Process Control Equipment. To prevent injury resulting from accessibility to live parts the equipment must be installed in an enclosure. The power Supply unit must comply with NEC Class 2, as described by the National Electrical Code® (ANSI / NFPA 70).

## IECEX, ATEX and UKEX installation in Zone 2

IECEX KEM 10.0068 X . . . . . Ex ec IIC T4 Gc

Only 3225B. . . . . Ex ec nC T4 Gc

KEMA 10ATEX0147 X . . . . . I 3 G Ex ec IIC T4 Gc

Only 3225B. . . . . II 3 G Ex ec nC IIC T4 Gc

DEKRA 21UKEX0055X . . . . . II 3 G Ex ec IIC T4 Gc

Only 3225B. . . . . II 3 G Ex ec nC IIC T4 Gc

For safe installation, the following must be observed. The device shall only be installed by qualified personnel who are familiar with the national and international laws, directives and standards that apply to this area.

The devices shall be installed in a suitable enclosure providing a degree of protection of at least IP54 according to EN IEC 60079-0, taking into account the environmental conditions under which the equipment will be used.

When the temperature under rated conditions exceeds 70°C at the cable or conduit entry point, or 80°C at the branching point of the conductors, the temperature specification of the selected cable shall be in compliance with the actual measured temperature.

To prevent ignition of the explosive atmospheres, disconnect power before servicing and do not separate connectors when energized and an explosive gas mixture is present.

For installation on power rail in Zone 2, only Power Rail type 9400 supplied by Power Control Unit type 9410 is allowed.

Do not mount or remove devices from the power rail when an explosive gas mixture is present.

## Document history

The following list provides notes concerning revisions of this document.

<b>Rev. ID</b>	<b>Date</b>	<b>Notes</b>
100	2204	Initial release of the product.

# We are near you, *all over the world*

**Our trusted red boxes are supported wherever you are**

All our devices are backed by expert service and a 5-year warranty. With each product you purchase, you receive personal technical support and guidance, day-to-day delivery, repair without charge within the warranty period and easily accessible documentation.

We are headquartered in Denmark, and have offices and authorized partners the world over. We are a local

business with a global reach. This means that we are always nearby and know your local markets well. We are committed to your satisfaction and provide **PERFORMANCE MADE SMARTER** all around the world.

For more information on our warranty program, or to meet with a sales representative in your region, visit [prelectronics.com](http://prelectronics.com).

# Benefit today from *PERFORMANCE MADE SMARTER*

PR electronics is the leading technology company specialized in making industrial process control safer, more reliable and more efficient. Since 1974, we have been dedicated to perfecting our core competence of innovating high precision technology with low power consumption. This dedication continues to set new standards for products communicating, monitoring and connecting our customers' process measurement points to their process control systems.

Our innovative, patented technologies are derived from our extensive R&D facilities and from having a great understanding of our customers' needs and processes. We are guided by principles of simplicity, focus, courage and excellence, enabling some of the world's greatest companies to achieve PERFORMANCE MADE SMARTER.